

**BRICK TECHNICAL BULLETIN
MOVEMENT CONTROL****BTB 5**

This Technical Bulletin outlines in brief terms the mechanism behind the performance of Edenhall bricks, particularly in regard to movement, and offers some comments and suggestions as to how that should be considered when designing to accommodate that movement in buildings. It should be stressed however that the frequency and location of movement joints is not a precise science and are influenced by many factors including those detailed in the Design Considerations section and consequently this Bulletin can only offer general advice.

INTRODUCTION

All building materials move in one way or another, either from drying shrinkage, moisture movement (absorption and drying out), thermal effects or structural movement. *Concrete bricks are not unique in this respect.*

People's perceptions of drying shrinkage and hence cracking in concrete can stem from their experiences with traditional wet cast/poured concrete. The mechanism of shrinkage in concrete commences with the drying out of excess mix water within the matrix. Other factors such as the final water absorption; type of curing; cement content; aggregate type; density; and compressive strength can all affect the amount of movement. Edenhall bricks specifically can claim:

- Low cement and mix water contents with a high aggregate ratio giving low volume changes within the brick matrix.
- Low water absorption of the cured brick leading to reduced moisture changes thus minimal moisture movement changes.
- Inherent high strength of the brick for relatively low cement content producing "stiffer" units which can resist internal stresses.

Edenhall bricks with the above characteristics therefore offer some of the lowest shrinkage and moisture movement values of cement based masonry units used today.

Movement in a structure can either be controlled or localised in order to minimise internal stresses in the brickwork which may cause cracking. The provision of movement or control joints offers an opportunity to localise that movement into a preferred position where it can be best accommodated. Alternatively the introduction of bed joint reinforcement at the appropriate locations can dissipate any stresses and/or allow an increase in spacing between joints.

It is widely accepted that the degree of movement is extremely difficult to predict. For example, Edenhall bricks, which have a natural tendency to shrink when drying, will also expand when subject to moisture or thermal effects. These differential movements, which occur in different directions, can in many instances nullify each other.

Although it is theoretically possible to just quote an arbitrary figure of 6-9 metres for spacing between vertical joints, in practice the designer should take into account other factors such as orientation of the wall in relation to the sun; number and position of openings; shape and slenderness of the panels; moisture content of the bricks; past experience; and utilise Edenhall's extensive knowledge of the product we supply.

The National House Building Council (NHBC) initially made general recommendations of maximum spacing of 6 metres for vertical joints using concrete masonry products. This advice was acceptable for the generic group of cement based masonry but it was recognised that concrete masonry encapsulates a wide variation of product groups ranging from Autoclaved Aerated Blocks with a low strength and high drying shrinkage through to a Dense Masonry Brick of high strength and low shrinkage. The NHBC had adopted the lowest performance characteristics of any product within the concrete products group as a guide for the spacing of joints without consideration of the individual product characteristics. In simple terms these characteristics influence the degree of movement and hence joint spacing. For Edenhall bricks these can be summarised as high density; low drying shrinkage; high strength; high modulus of elasticity; and low water/cement ratio.

In a communication from NHBC in April 2014 they accepted that the 6 metre rule for joint spacing for concrete bricks could be waived and that the recommendations given in BS 5628-3 and its subsequent document PD 6697 should be utilised. This states that joint spacing of between 6-9 metres may be acceptable but that designers should consult the manufacturer (eg. Edenhall) over the use of their specific products given the manufacturer's past experience and knowledge. As the leading concrete brick manufacturer in Europe, Edenhall has a wealth of experience in all aspects of the use of concrete bricks.

Consequently Edenhall's recommendations are that movement control measures are incorporated at 7.5-9 metres subject to panel profile, position and size of openings, and site practice.

These spacings have also been recognised by other insurance agencies such as LABC and Checkmate.

CONCRETE TECHNOLOGY

When concrete dries out it contracts and shrinks. When it is extracted from the mould in its uncured state it is as large as it is ever going to be but as it cures it shrinks but expands again when wetted. That expansion does not occur to the same extent as the shrinkage. These volume changes due to variations in moisture content are an inherent characteristic of hydraulic cement based concretes. The volume and type of aggregate and cement content have a significant effect on the magnitude of these volume changes. *Since Edenhall bricks are produced with a relatively low cement content and use low shrinkage aggregates the volume changes are low.*

The requirement within BS EN 771-3, "Specification for Concrete Masonry Units", sets no limits for shrinkage or moisture movement and the values for Edenhall bricks can be found with the individual CE and DOP documents. Designers should take into account these values when comparing against other concrete masonry materials. However independent tests carried out on Edenhall bricks show a typical Facing Brick to have the following values:

Drying Shrinkage:	0.07 – 0.17	mean	0.12mm/linear metre
Moisture Movement:	0.12 – 0.17	mean	0.14mm/linear metre
Total Movement Coefficient:			0.26mm/linear metre

Note:

The test method measures the moisture expansion between the bricks at initial ambient condition and after soaking in water for four days and then the shrinkage between that saturated value and after drying for 21 days @ 33°C. The sum of these gives the total movement coefficient. These are extreme conditions – in effect measuring from absolute saturation to complete oven dry – a condition unlikely to occur in practice on site. Indeed research in Canada estimates that actual shrinkage and moisture movement is probably only half that compared with a standard test. It should also be noted that the effects of shrinkage due to drying may be compensated for by the thermal expansion due to solar effects.

DESIGN CONSIDERATIONS

Types of Movement:

Movement in a structure can arise from the effects of:

- Thermal influences
- Shrinkage and moisture movement characteristics of the external masonry
- Changes in the orientation or shape of a building
- Site practice
- Type and grade of mortar

The tendency for all concrete products is to shrink slightly over time and when drying out, although they may revert back to near their original size when subject to moisture. Like all materials they are also subject to thermal movement. Consequently the location of movement joints is to define the most appropriate position to accommodate this movement whilst considering the aesthetic, practical and structural factors.

Mortar Choice:

The recommended movement joint spacing of between 7.5-9 metres assumes the use of a Type iii (compressive strength M4) mortar, ie. 1:1:6 or equivalent. Stronger mortars, which have higher shrinkage values, may necessitate the reduction in spacing of joints down to 6 metres. Lime based mortars, with their degree of flexibility to accommodate movement, offer better characteristics than pure sand/cement based mortars. ***For further information on Mortar Selection see Technical Bulletin [BTB 4](#).***

Site Protection:

Since bricks shrink slightly as they dry out it is important that they are kept as dry as possible before laying. Opened packs should be covered up, as should bricks after they have been stacked up around the site. Incomplete brickwork should be protected as this will minimise the risk of shrinkage and efflorescence leaching from around the mortar joints.

Thermal Movement:

South facing walls, particularly those built of dark coloured bricks, are more susceptible to thermal movement than other elevations. Whereas a simple contraction joint may suffice in more sheltered elevations, joints for southern facing elevations should have movement joints which are capable of responding to both expansion and contraction. If movement joints are not practical in these elevations then the use of bed joint reinforcement should be considered above and below large openings.

Dissimilar Materials:

In certain instances different masonry materials may be combined within the same elevations. In the case of clay bricks, which have expansive properties, and concrete bricks, which may shrink slightly, it is important to make provision for this differential movement.

Where for example a clay brick is used up to dpc level and an Edenhall brick built as the superstructure, then the dpc itself may act as a slip plane and allow the differential movement to occur. This can be dependent on the dead load on the dpc and an Engineer's advice should be sort as to whether a single dpc is adequate or whether two layers would be required. In all cases provision should be made to ensure structural stability.

If two dissimilar materials are mixed on one elevation then slip planes should be introduced or bed joint reinforcement incorporated to dissipate the areas of tensile stress. Again, provision must be made to ensure that structural stability is not compromised.

Length/Height Ratio and Panel Shape:

The relevant Standards, BS 5628-3 and PD 6697 recommend that the length/height ratio of panels should not exceed 3:1. Shape is as crucial as arbitrary length. For example, a long garden wall of single leaf construction which is unloaded will have a greater tendency for movement and hence cracking than a two storey box type dwelling. With a 1 metre high garden wall, movement joint spacing of 9 metres would be excessive as this well exceeds the 3:1 ratio, whereas a two storey elevation averaging 5.5 metres in height could accommodate a movement joint at 9 metres or greater.



Figure 1.

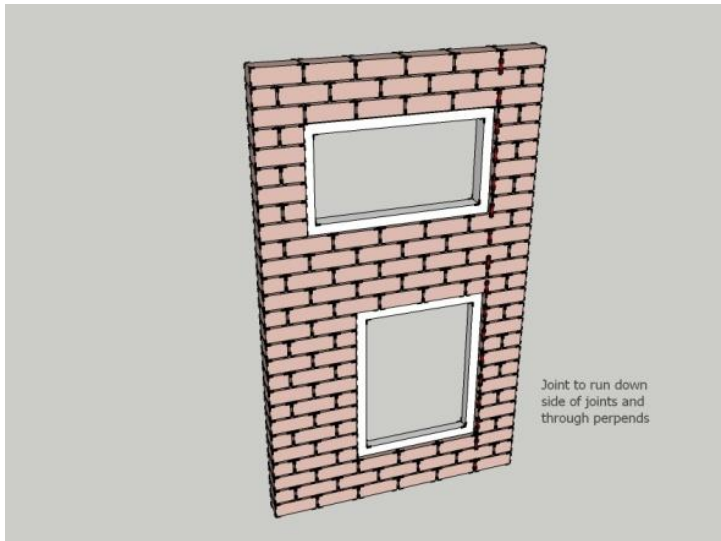

Figure 2.

The superstructure should be viewed as a series of panels. For example in elevations where window openings are long in comparison to their height, or where those types of openings are stacked above each other, this may result in the brick panels in between the windows being less than 7.5-9 metres but exceeding the 3:1 ratio. In these instances vertical joints in line with the jambs may need to be considered, or alternatively bed joint reinforcement introduced to dissipate the stresses within the panel. The example shown in Figure 1 may be suitable for those openings where brick soldier courses are used as cills and heads, but if Artstone or precast cills and heads are used then the designer should consider the practical difficulties of installing a movement joint which follows around the bed joint and at the end of those components.

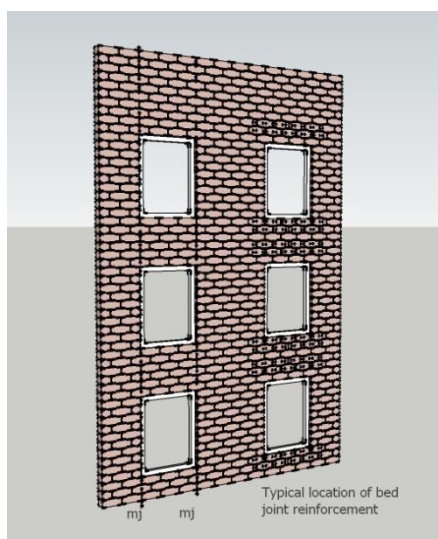

Figure 3.



Figure 4.

Particular care should be taken where there are large openings above each other, eg. 1.5 metres plus, but with only low panels of brickwork above or below them. In these instances it may be appropriate to incorporate bed joint reinforcement above and below the openings. See Figures 3 and 4. This is particularly important where the panel between the openings is long in relation to its height and there are large areas of brickwork either side of that panel. By contrast a small, narrow window within a gable may not require the introduction of any specific control measures if it is surrounded on all four sides by large areas of brickwork.

LOCATION OF MOVEMENT JOINTS

Movement joints should be introduced in areas of potential stress such as detailed in *Figures 5, 6 and 7* below.. If joints are placed near adjacent structural members, eg. columns and beams, they should incorporate a flexible compressible filler between the brickwork and member to allow for the absorption of movement and flexure under load, as well as providing a fire stop.

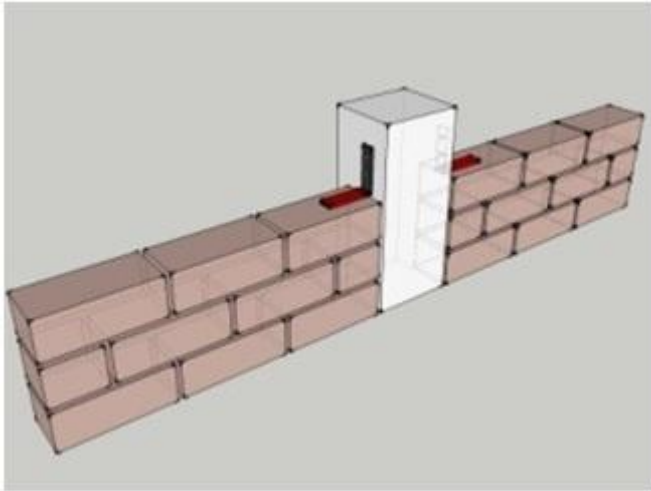

Figure 5

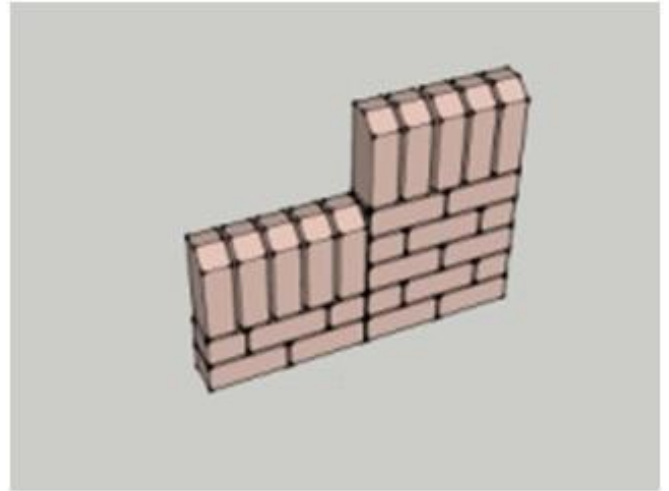

Figure 6a

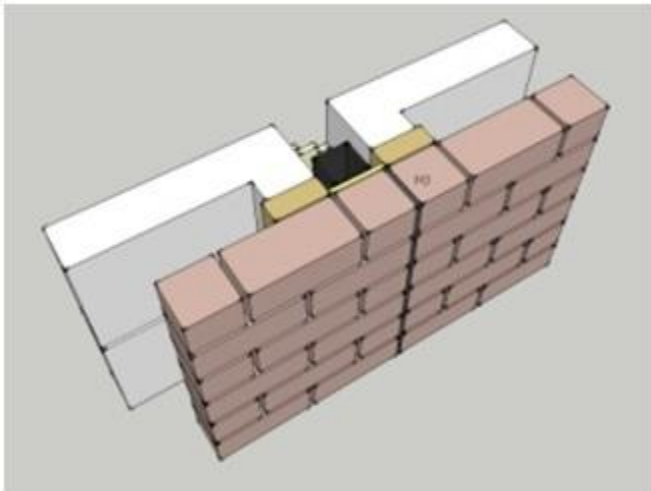

Figure 6b

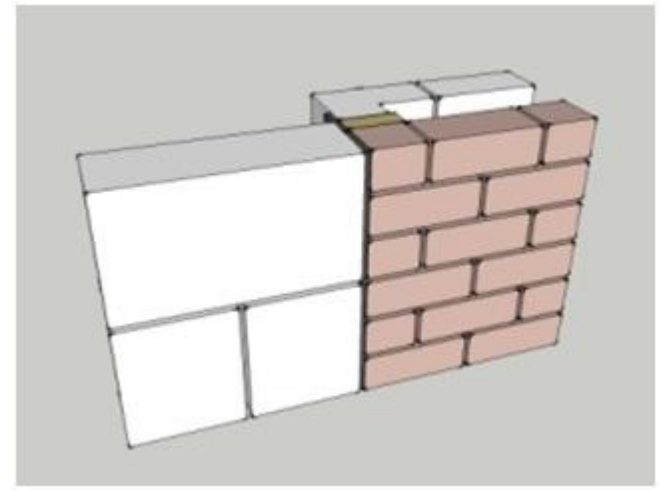

Figure 6c

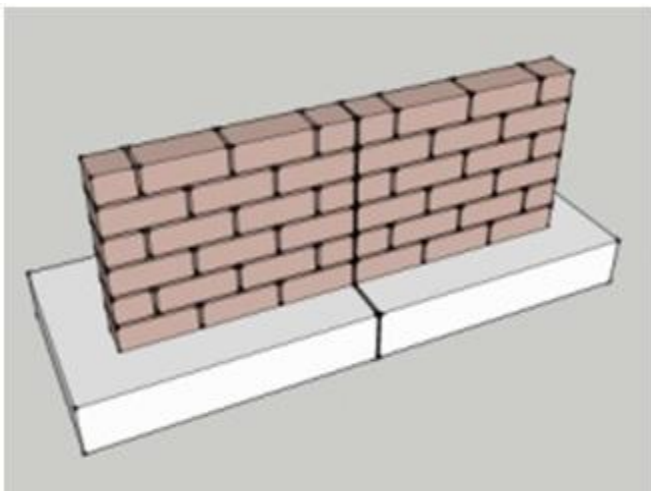

Figure 7a

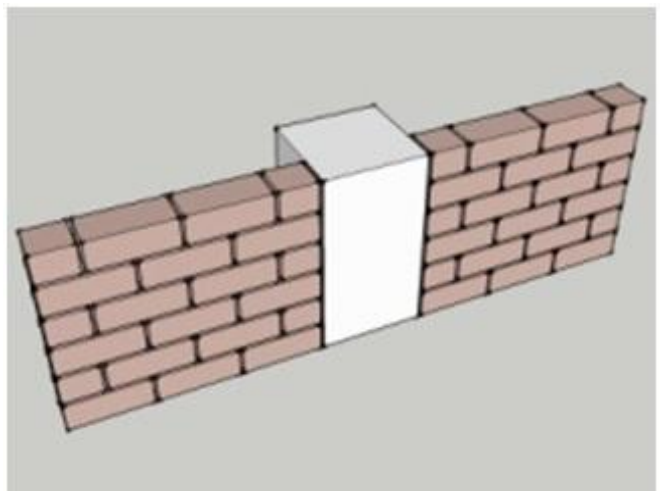
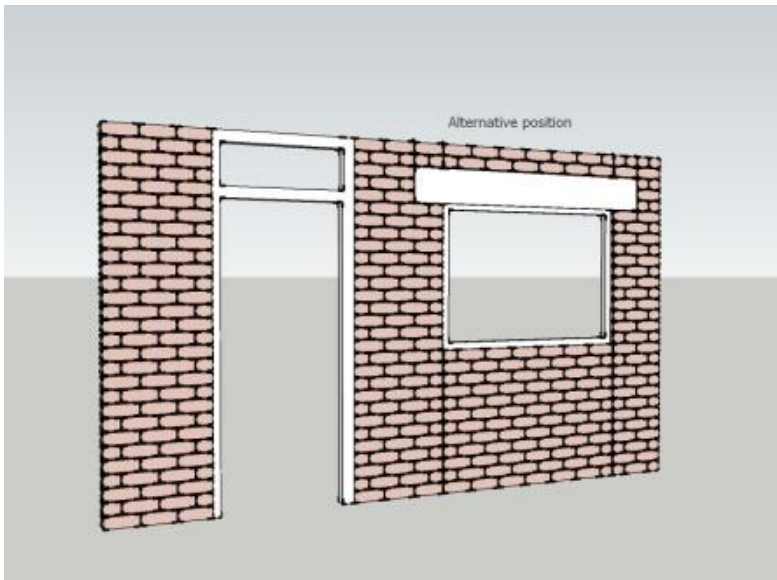

Figure 7b



Where possible break up the elevations into discrete panels as demonstrated in *Figure 8*.

Note:

The window detail example shown frequently occurs on upstairs windows below the wall plate where only one or two courses of brickwork exist above the lintel. In these instances a contraction joint, which acts as a crack inducer, can be installed running vertically up the line of the jambs or ends of the lintels (see *Figure 14*). This can be filled with mastic and will have the effect of localising any potential cracking.

Figure 8

Use bed joint reinforcement as an alternative or supplement to the movement joints at areas of the greatest tensile stresses. Joint reinforcement can be used in elevations where the division of the wall into panels is impractical. See *Figure 9*.

Note:

Full details on the use and application of bed joint reinforcement is available from the manufacturers.

The use of bed joint reinforcement should be especially considered if the openings are greater than 1.5 metres.

Bed joint reinforcement cannot fully replace the necessity for movement joints but it can allow an elimination or increase in the spacing of joints by up to 50%.

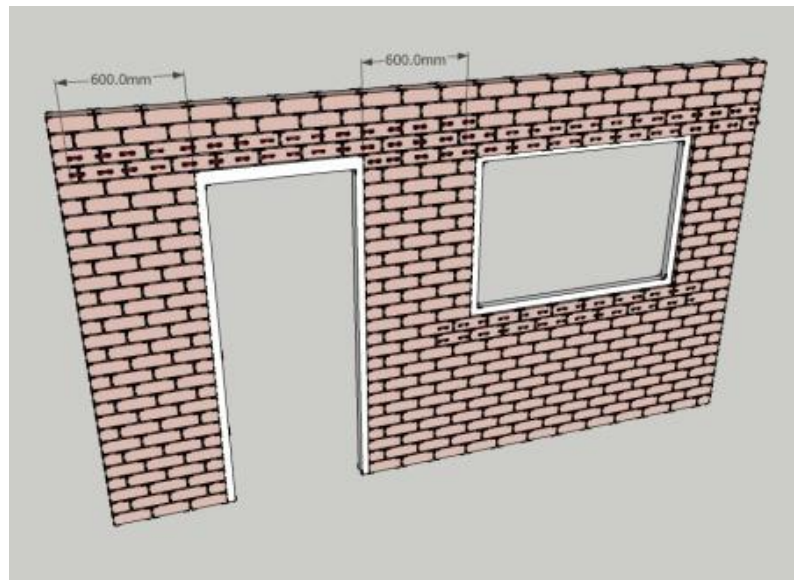
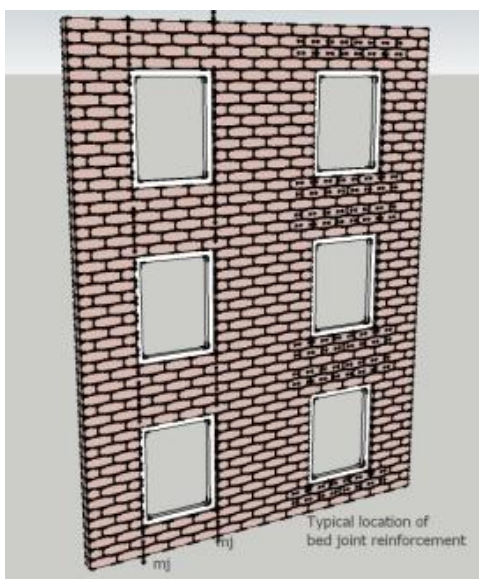

Figure 9



Areas of weakness also occur when the openings are wide in relation to their height or where large openings are positioned vertically above each other. In these instances vertical joints should be considered adjacent to the jambs or bed joint reinforcement introduced. See *Figure 10*.

Figure 10.

JOINT SPACING

Edenhall's experience in the supply of Facing Bricks, which can be demonstrated by numerous sites across the country, shows that as a general rule vertical movement joints may only need to be incorporated at 7.5-9 metre centres. Certain shapes of buildings, for example cube shaped two storey buildings with elevations of between 6-9 metres in length, may not require joints at all **depending on the frequency, size and location of openings**. A typical two storey semi-detached block may only require joints at the party wall junctions provided the correct mortar has been used and the bricks have been built when dry. See *Figures 11, 11a and 11b*.

Note:

The long/low shape of the panel between the windows may require the introduction of bed joint reinforcement. If the gable end is south facing consideration should be given to incorporating a movement joint in the centre.

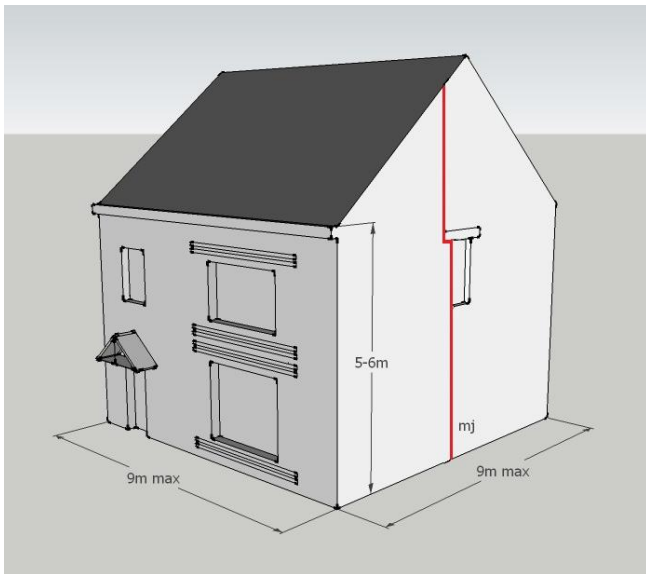

Figure 11

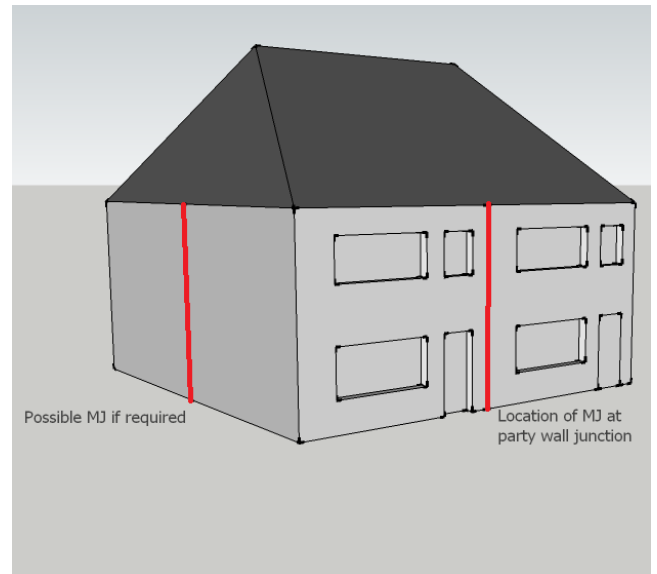

Figure 11a

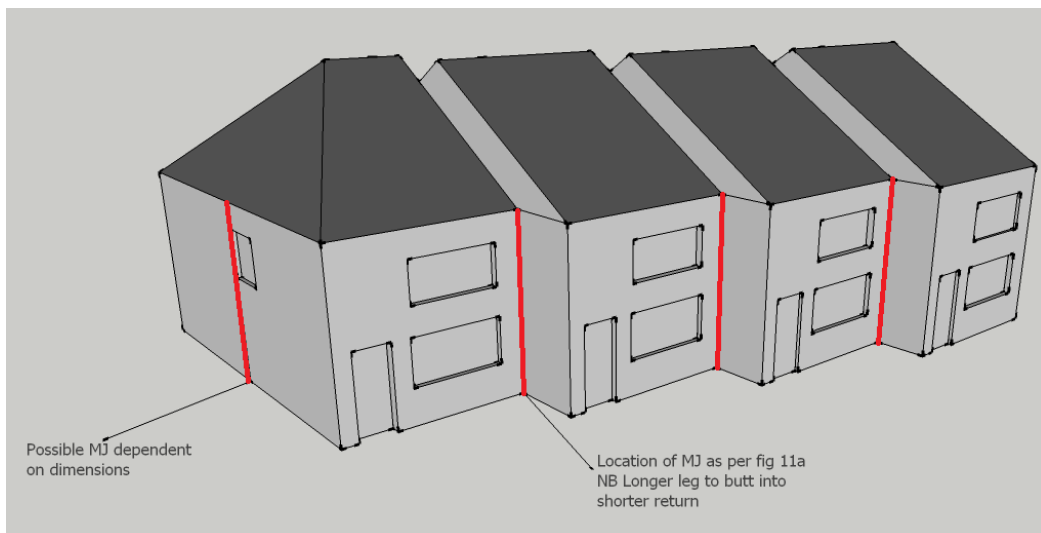

Figure 11b

The length of a panel can also include a return provided the overall panel length is within the allowed parameters. See *Figures 12 and 12a*.

Vertical movement can be considered to be of the same magnitude as horizontal movement and in buildings exceeding four storeys or 12 metres in height joints should be generally positioned at every second storey.

Consideration should also be given to the movement in timber frame buildings and the necessary provisions made to accommodate shrinkage of the frame.

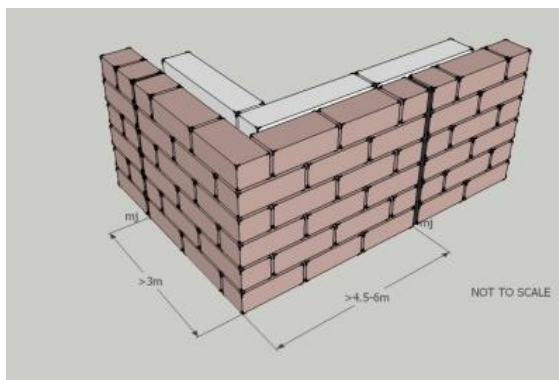

Figure 12.

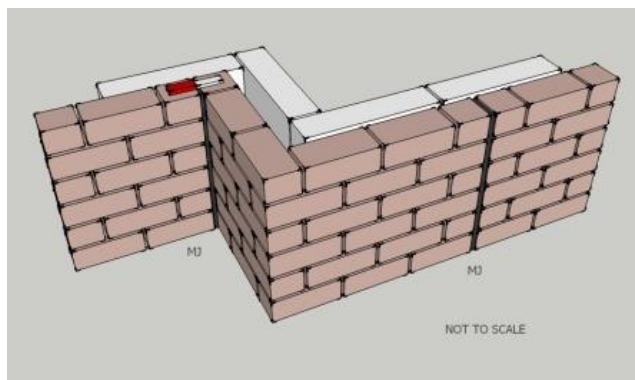

Figure 12a.

TYPES OF JOINT

In a large percentage of cases movement joints for Edenhall bricks can be installed as contraction joints apart from those elevations that may be subject to excessive thermal movement thus requiring joints which are compressible as well as allowing for contraction. In these instances the filling material in the joints should be easily compressible. Flexible materials such as polyurethane, polyethylene or foam rubber are suitable.

For contraction joints fibre board or similar materials are suitable but care should be taken that the backing material does not dislodge after any contraction of the brickwork has taken place. Joints should be sealed to resist any water ingress. BS 6213 gives further details. Joints for Edenhall bricks should normally be 10mm wide.

Typical joint types are shown in *Figures 13, 14 and 15*.

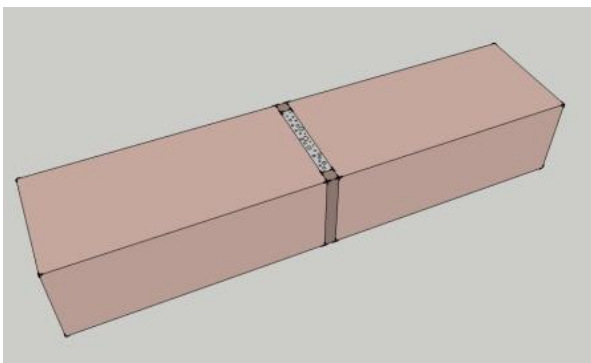

Figure 13: External movement joint with compressible filter

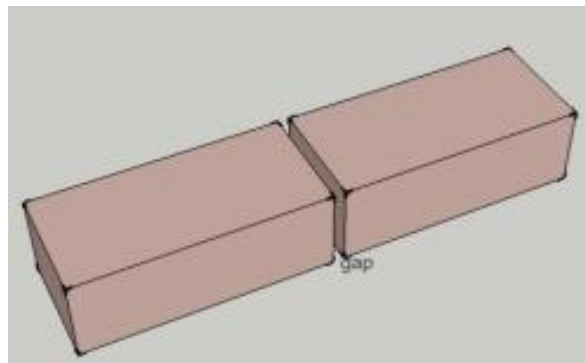

Figure 14. Internal contraction joint

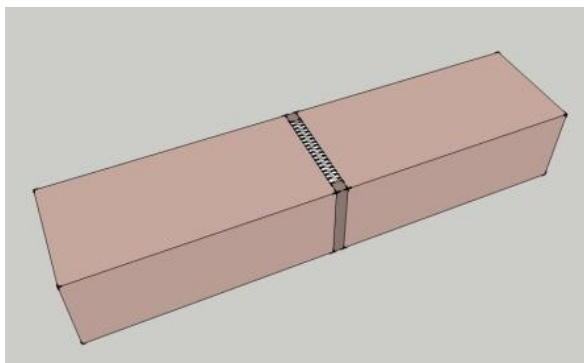

Figure 15 External contraction joint, mortar raked back and joint filled

Contraction joints would also be used on internal walls where there is unlikely to be any significant expansion. In these instances a simple raking out of vertical joints between the units may be sufficient to localise any potential cracking. In other locations the choice of flexible filler and sealant should be adequate for the anticipated movement. Care should be taken that adequate stability is provided across the joint by the incorporation of extra ties in a cavity wall or by the installation of horizontal flat ties across the joint. See *Figures 16 and 17*.

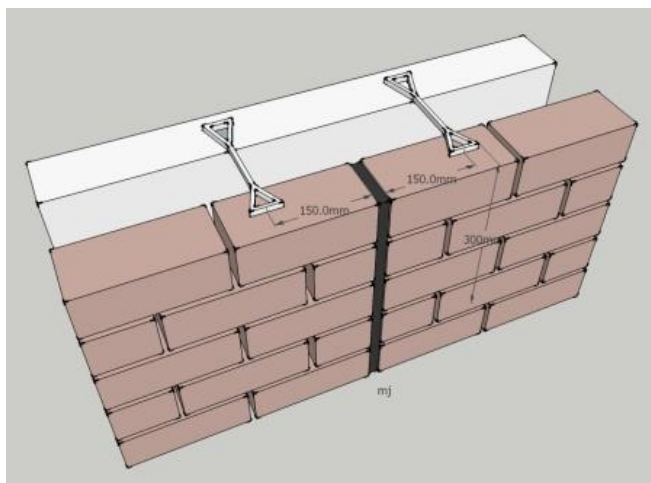

Figure 16.

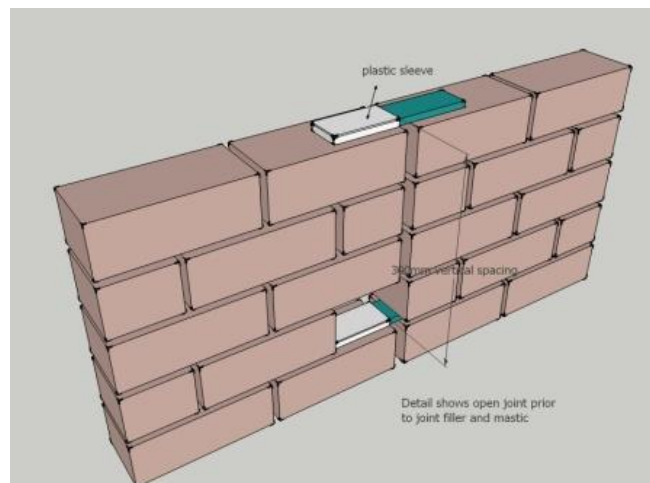

Figure 17.

JOINTS BELOW DPC

NHBC Standards, Clause 6.1, D3 (g) says “Any movement joints provided in the substructure must be carried up into the superstructure. Movement joints may be needed in the superstructure where none are required in the substructure – however suitable allowance should be made for relative movement.”

In the case of Edenhall bricks below dpc the element of shrinkage is minimal, but in accordance with the NHBC Guidance the following should be taken into consideration:

- Where the dpc is less than 600mm above ground level, movement joints do not generally need to extend below the dpc.
- Where the dpc is more than 600mm above ground level, consideration should be given to continuing the joint through the masonry below the dpc.
- Where the movement joint is provided for differential ground movement, for example (a) at major changes in foundation level or (b) between foundations of different designs or at variations in the height of buildings, the movement joints should continue through the brickwork below the dpc.

WALL TIES AND SLEEVED TIES

According to document PD 6697, Clause 6.2.2.2., the density, ie. wall ties per square metre, should be in accordance with BS EN 1996-1-1:2005 where the ties are distributed evenly except around openings and movement joints where they should be installed at vertical heights of 300mm, not more than 225mm from the edge of the joint. Alternatively the incorporation of flat wall ties, one end of which is de-bonded, will allow relative movement whilst still maintaining stability.

BONDING TO THE INNER LEAF

Where external joints are to be coincidental to any internal blockwork joints then those joints should be staggered vertically by a minimum of 450mm.

See *Figure 18*.

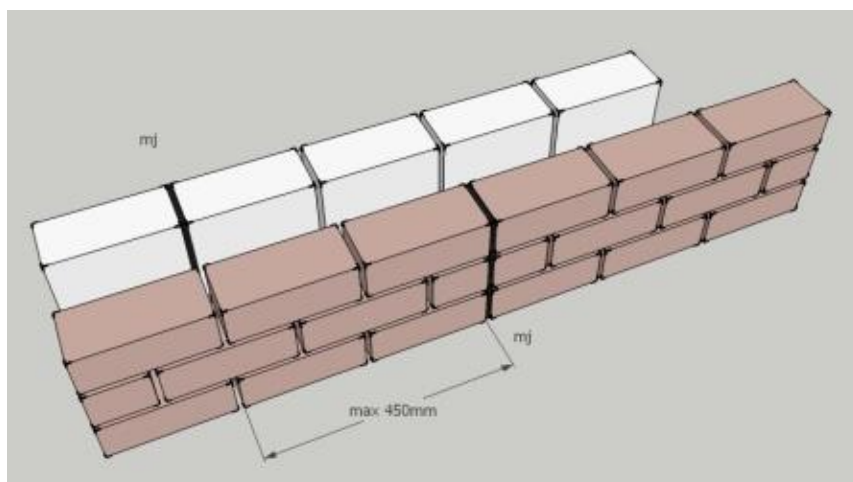
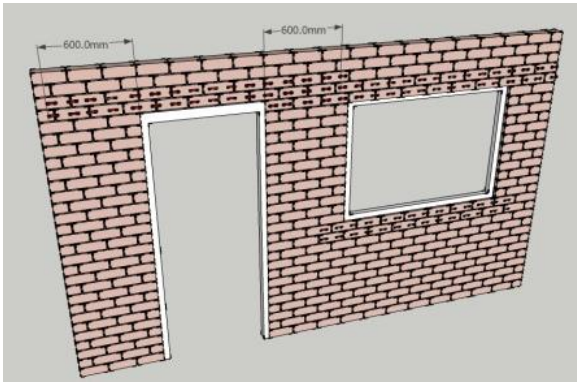

Figure 18.

BED JOINT REINFORCEMENT



The introduction of bed joint reinforcement can be used to distribute stress around openings or as an alternative to a vertical movement joint if that joint location is either not practical or aesthetically acceptable. Bed joint reinforcement is not a substitution for movement joints but there is evidence from manufacturers/suppliers that spacing of joints can be increased by up to 50% depending on the circumstances. Bed joint reinforcement must not extend past the movement joint and should be installed in accordance with the manufacturer's recommendations. The reinforcement should be of the ladder/lattice type as opposed to the expanded mesh version. See *Figure 19*.

Figure 19.

RETROSPECTIVE INSTALLATION OF MOVEMENT JOINTS

Although the inclusion of movement joints in the appropriate locations should have been provided for during design and construction, there are instances where they may have been omitted.

It is possible to retrospectively install joints into a building by cutting vertical contraction joints into the brickwork at the designated positions. These joints, which will be contraction joints, act as crack inducers and localise any shrinkage movement. They can be formed by cutting vertical joints, 10mm wide, down the face of the brickwork to a minimum depth of 75mm. In order to maintain the lateral stability of the wall, horizontal flat ties, one end of which is de-bonded, should be installed into the bed joints at 450mm centres. The bed joints can then be mortared up as normal. The vertical joints can either be filled with a flexible strip or weak mortar which is then faced with normal joint mastic.

PRACTICAL NOTES

- Joints can be incorporated at internal junctions if required. See *Figure 12a*.
- Utilise down pipes and soil pipes to hide joints where practical.
- If jambs of openings are directly above each other then a joint along the jambs can follow through vertically. If the jambs are staggered then bed joint reinforcement may be required.
- Introduce slip planes under any precast or art stone lintel if the joint is running up the side of a reveal and around the lintel.
- Joints should ideally be at least 300mm away from any reveal.
- Placing vertical joints at locations, where lateral support from party walls or load bearing internal walls exists, will assist in the stability and resistance to wind loading. See *Figure 20*.
- It is essential to keep bricks as dry as possible before and during construction.
- Use of bed joint reinforcement should be considered for all openings greater than 1.5 metres.

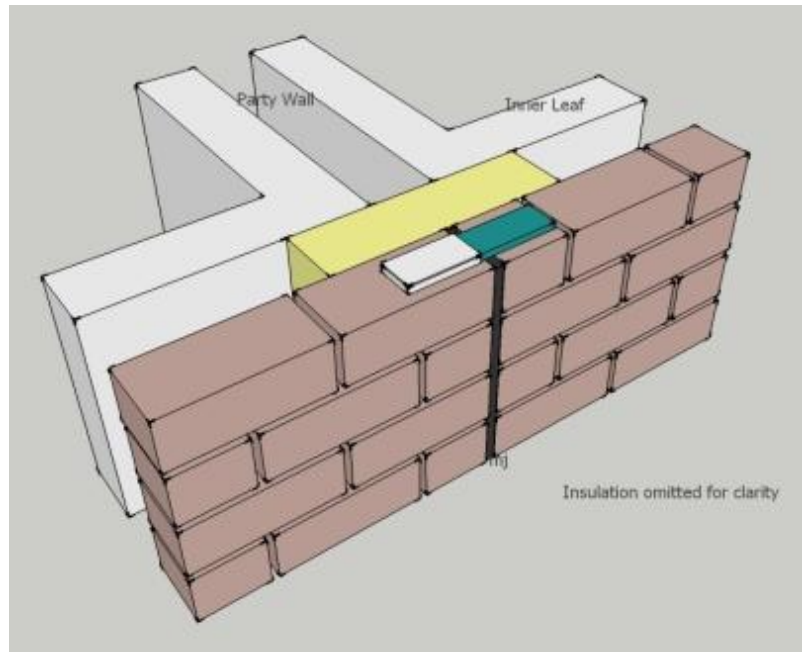

Figure 20.

Head Office:

PD Edenhall Ltd, Danygraig Road, Risca, Newport, NP11 6DP

Tel: 01633 612671

Fax: 01633 601280

www.edenhall.co.uk

The information and guidance contained in this Technical Bulletin is regularly reviewed as part of Edenhall's continuous development and improvement programme. Updates and amendments can be made without notice and the Company cannot accept liability for any errors or omissions. The content of this document and the referenced data sheets and bulletins, including tables, diagrams and images, are subject to copyright.